

Intra-Train Position and Angle Stabilisation at ATF Based on Sub-Micron Resolution Stripline Beam Position Monitors



N. Blaskovic Kraljevic, T. Bromwich, P. N. Burrows, G. B. Christian, C. Perry, R. Ramjiawan
John Adams Institute for Accelerator Science, University of Oxford, UK
D. R. Bett
CERN, Geneva, Switzerland



UNIVERSITY OF
OXFORD

A low-latency, sub-micron resolution stripline beam position monitoring (BPM) system has been developed and tested with beam at the KEK Accelerator Test Facility (ATF2), where it has been used to drive a beam stabilisation system. The fast analogue front-end signal processor is based on a single-stage radio-frequency down-mixer, with a measured latency of 16 ns and a demonstrated single-pass beam position resolution of below 300 nm using a beam with a bunch charge of approximately 1 nC. The BPM position data are digitised on a digital feedback board which is used to drive a pair of kickers local to the BPMs and nominally orthogonal in phase in closed-loop feedback mode, thus achieving both beam position and angle stabilisation. We report the reduction in jitter as measured at a witness stripline BPM located 30 metres downstream of the feedback system and its propagation to the ATF interaction point.

International Linear Collider

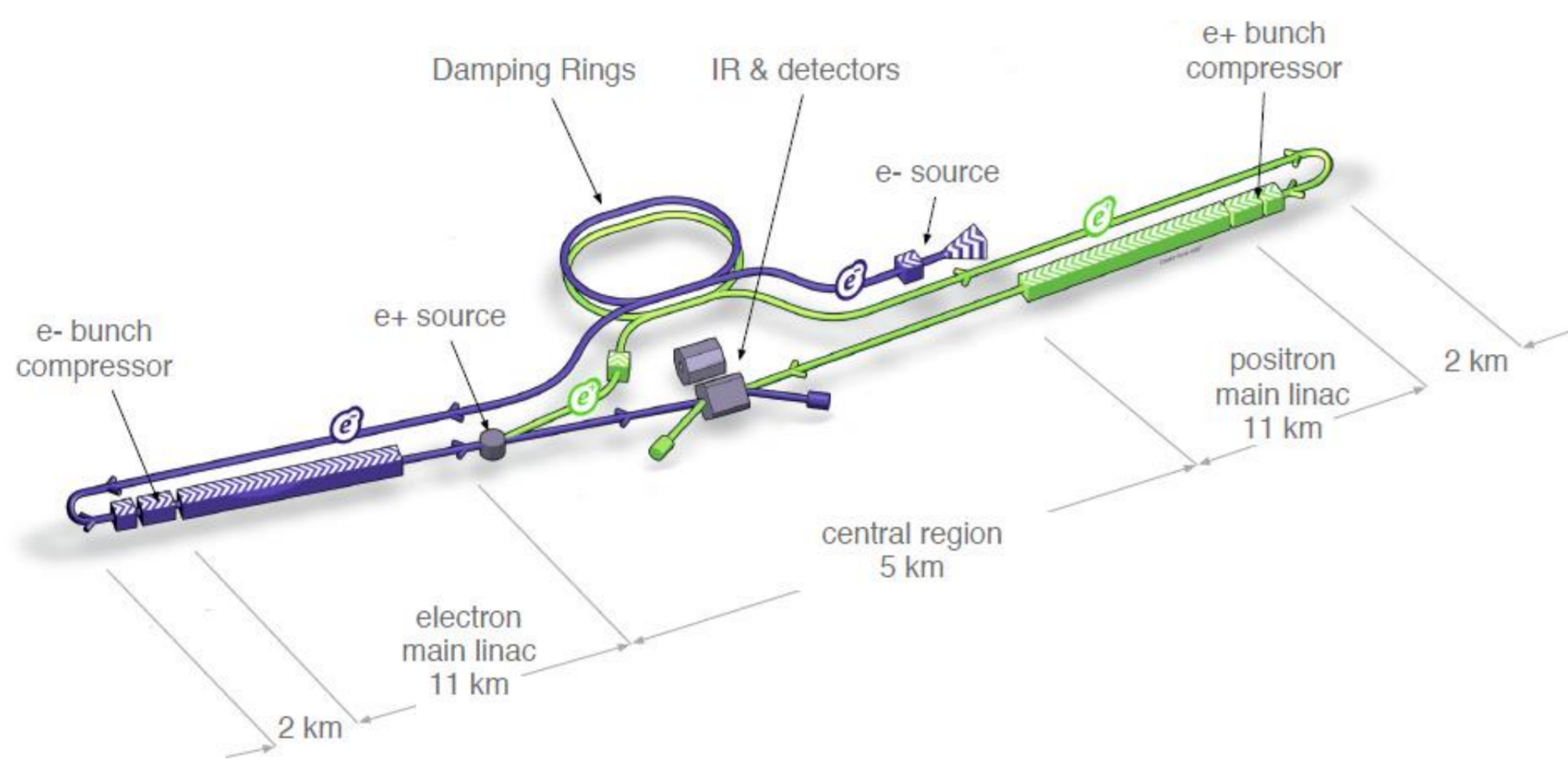

The design for future linear colliders, such as the 500 GeV electron-positron International Linear Collider (ILC) [1] pictured above, requires beams stable at the nanometre level at the interaction point (IP).

Accelerator Test Facility

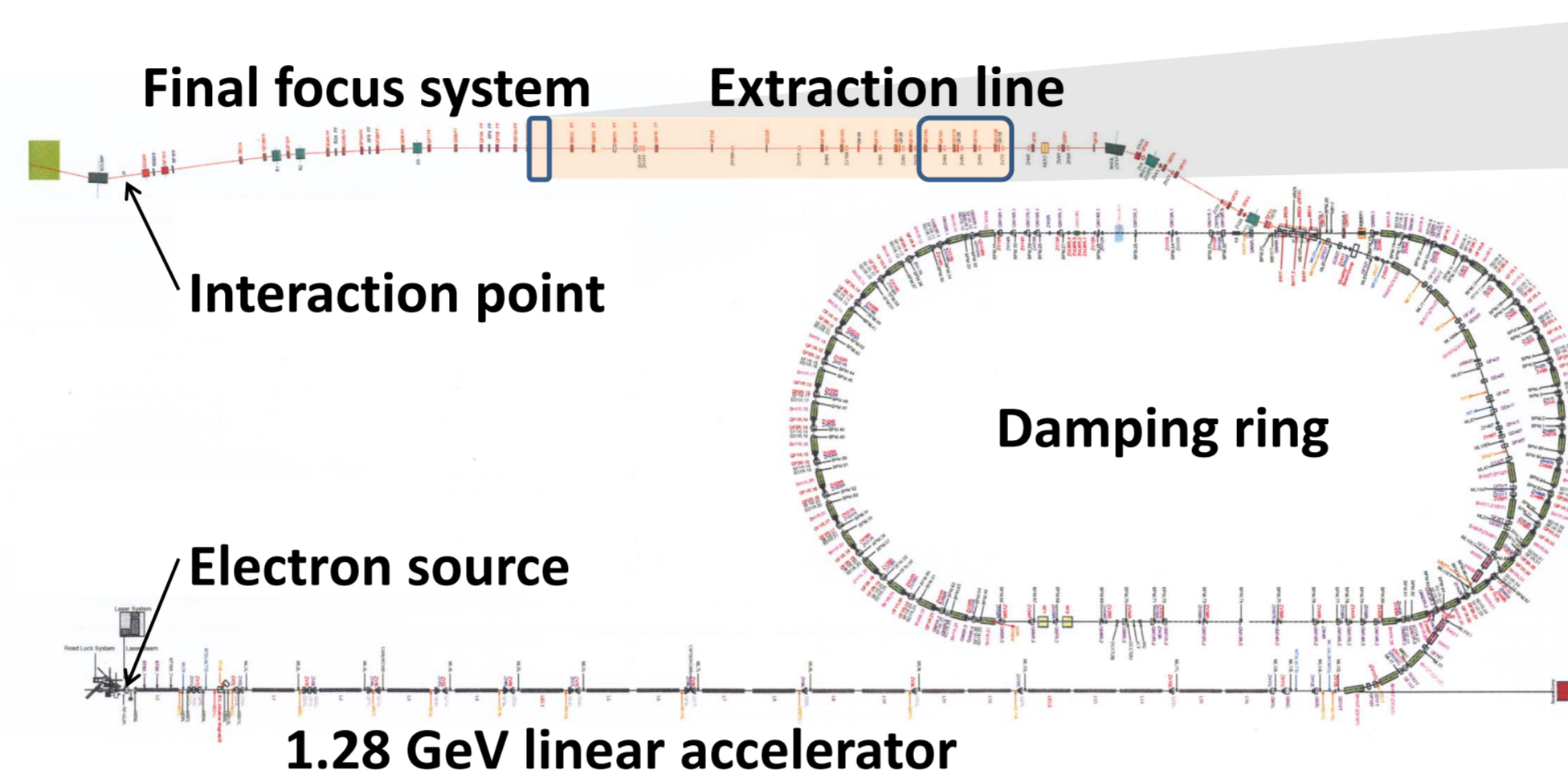

The Accelerator Test Facility (ATF2) [2] at KEK in Japan is a test facility for the ILC and aims to achieve position stability at the notional IP of ~ 2 nm. This goal requires stabilising the beam to under $1 \mu\text{m}$ in the extraction line [3].

Feedback on Nanosecond Timescales

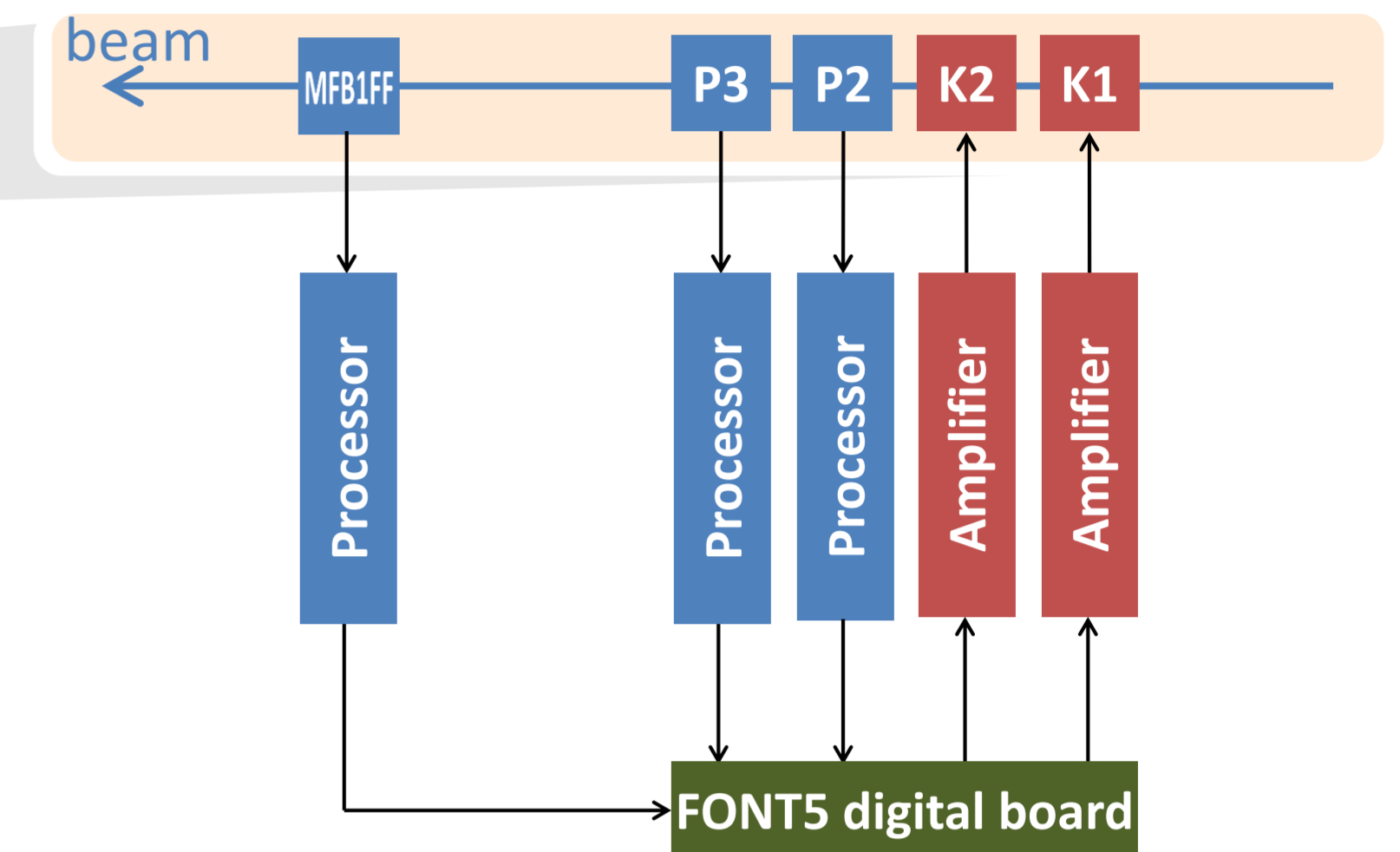

The Feedback on Nanosecond Timescales (FONT) [4] project performs intra-train beam-based feedback by measuring the bunch 1 position at P2 and P3 and applying a coupled-loop local correction to bunch 2 using kickers K1 and K2.

Stripline Beam Position Monitor

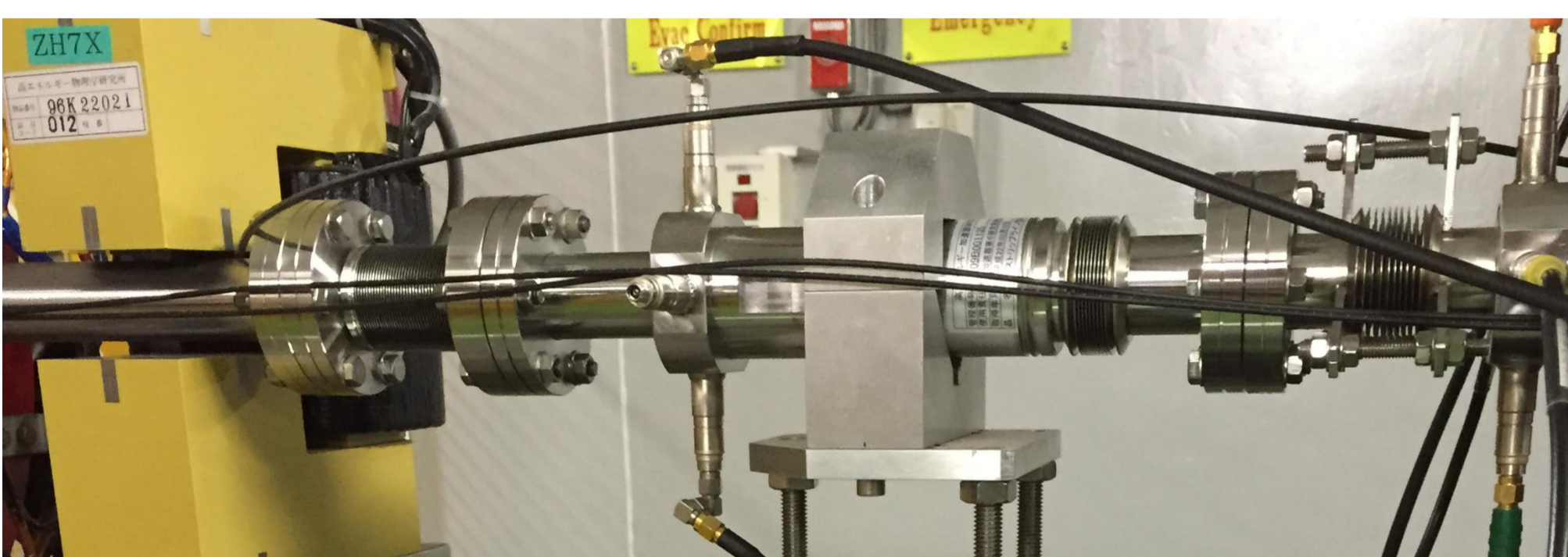

The FONT beam position monitoring system has three 12 cm stripline beam position monitors (BPMs) P1, P2 and P3, each on an x, y mover system. The witness stripline BPM MFB1FF is located ~ 30 m downstream. The BPM system has a resolution of ~ 300 nm with 0.5×10^{10} electrons/bunch [5].

Processor

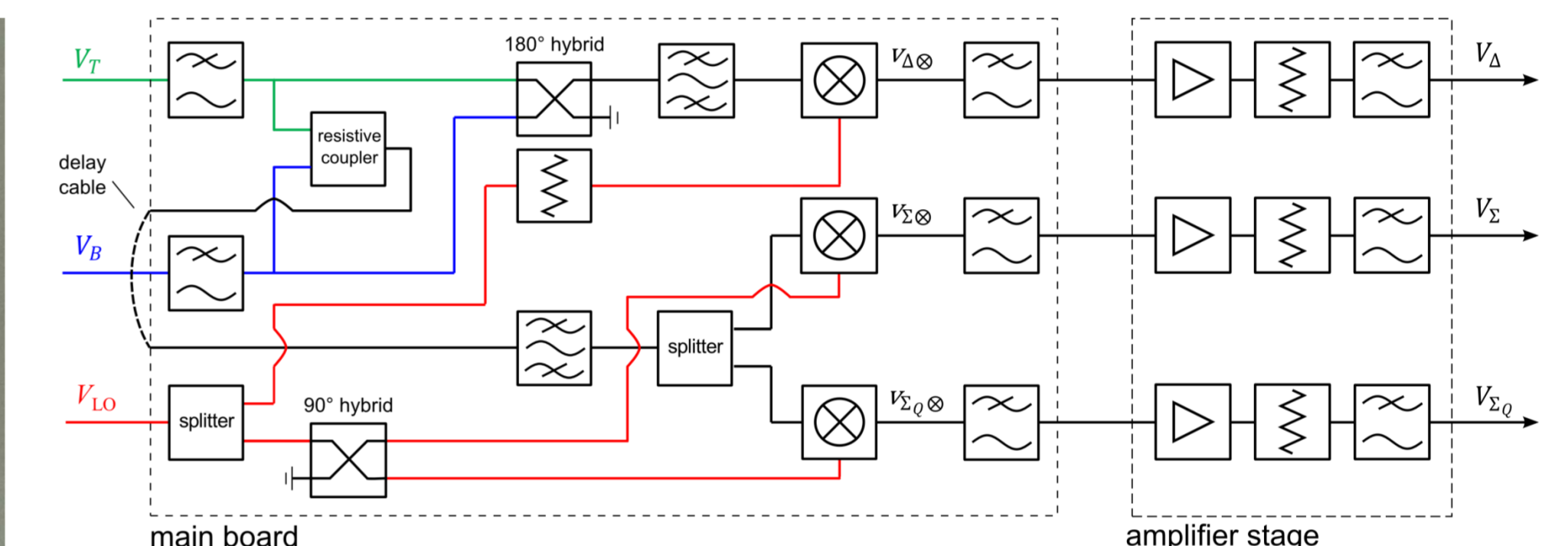
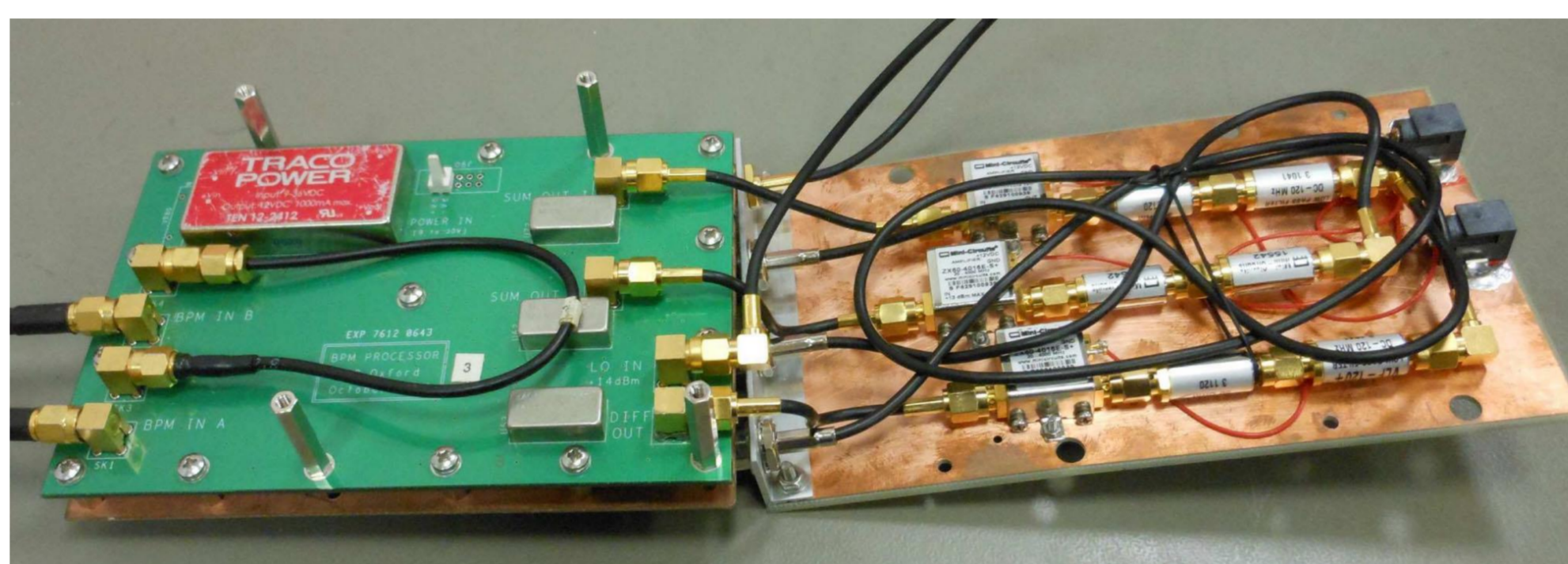

The top (V_T) and bottom (V_B) stripline BPM signals are subtracted using a 180° hybrid to form a difference (Δ) signal and are added using a resistive coupler to form a sum (Σ) signal. The resulting signals are then band-pass filtered and down-mixed with a 714 MHz local oscillator (LO) signal phase-locked to the beam before being low-pass filtered and amplified using 16 dB low-noise amplifiers. The LO is phased to the beam signal using a phase shifter on the LO input to the processor [5]. The output signals are digitised using analogue-to-digital converters (ADCs) on the FONT5 digital board, capable of converting at up to 400 MHz with 14-bit resolution.

Results

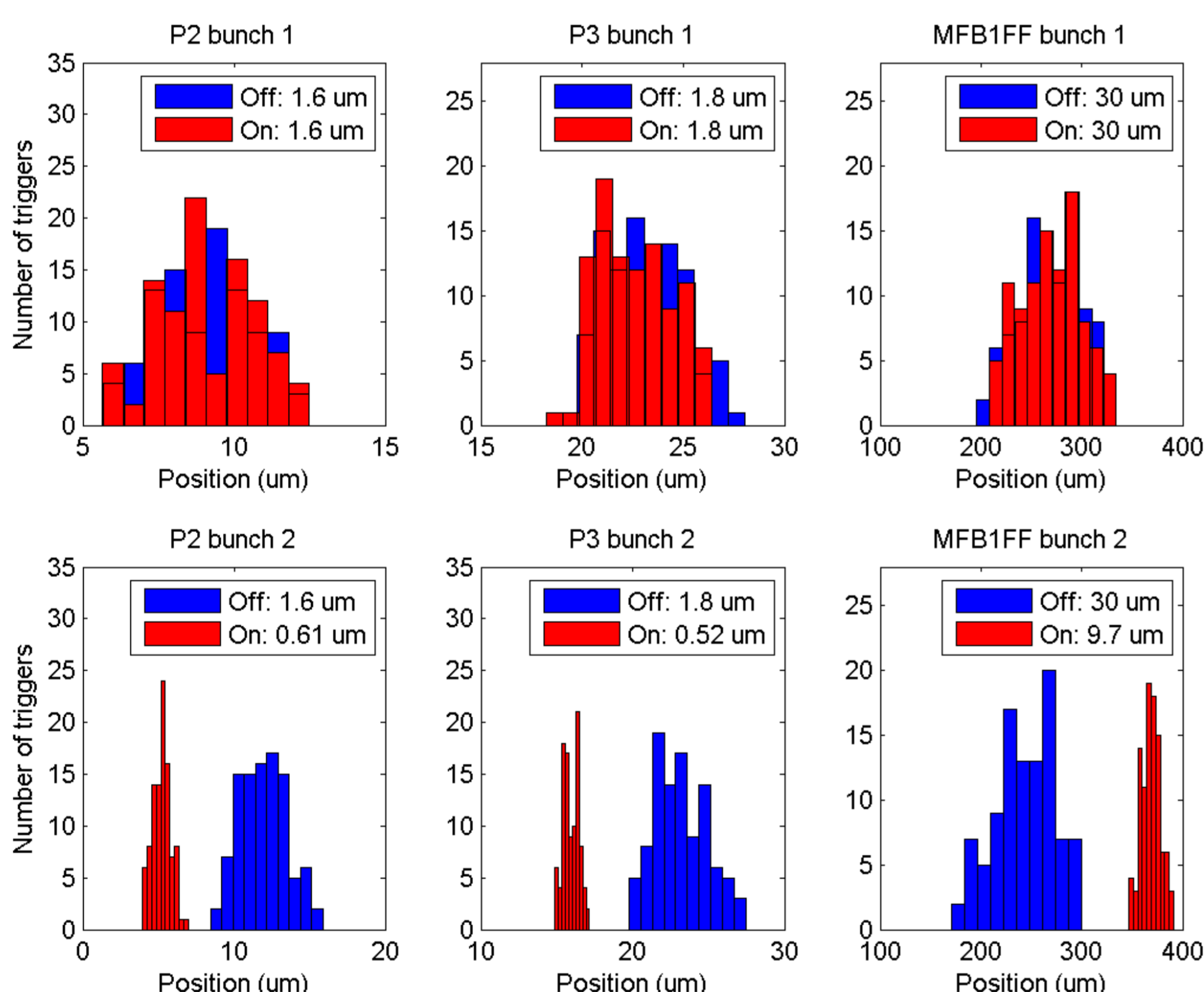

A factor ~ 3 reduction in the measured position jitter (quoted in the legend) is observed on comparing data without feedback (blue) to data with feedback (red) at P2, P3 and MFB1FF.

Beam Propagation

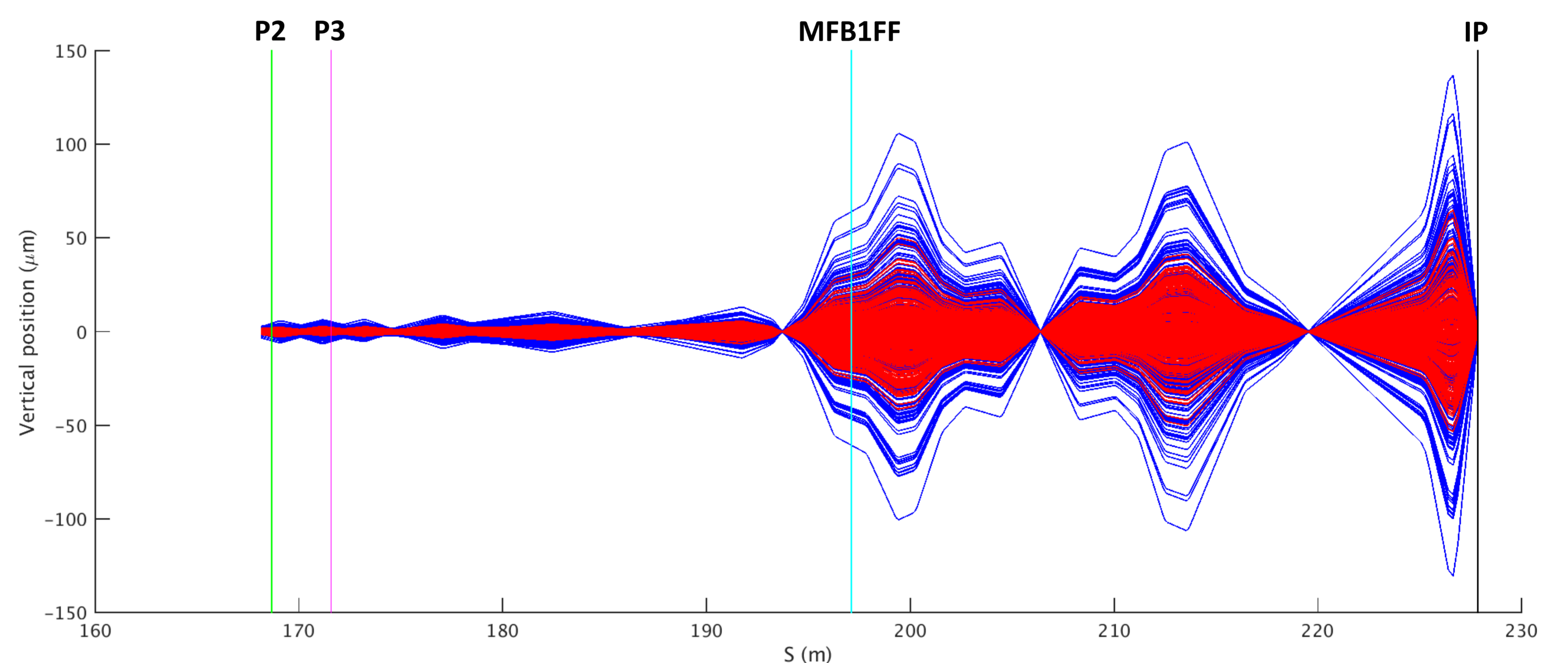

Taking the measured beam position without (blue) and with (red) the application of feedback at P2 and P3 allows the beam to be propagated through the lattice to the ATF2 IP. As the coupled-loop feedback acts in both vertical betatron phase advances, both the beam position and angle are stabilised downstream of the feedback system.

Dependence on Bunch Charge

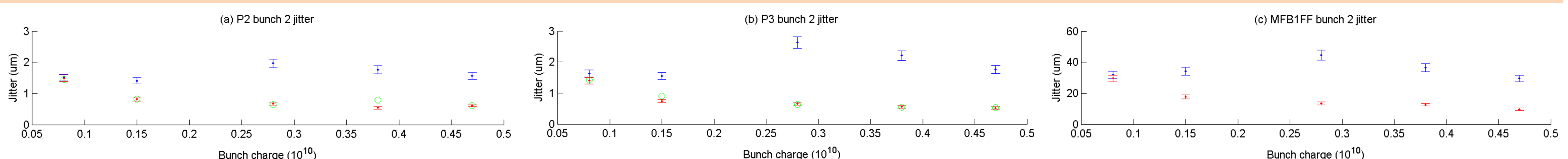

The position jitter without feedback (blue) and with feedback (red) are shown as a function of bunch charge. The lowest jitter with the feedback on is attained at a charge of $\sim 0.5 \times 10^{10}$, corresponding to the operating condition yielding the best BPM resolution of ~ 300 nm [5]. The points in green show the expected jitter on operating the feedback at the feedback BPMs P2 and P3 given the incoming values for the jitter of the two bunches and the bunch-to-bunch position correlation [6]. The attained performance is observed to agree with the expectation.

References

- [1] International Linear Collider: www.linearcollider.org/ILC/
- [2] Accelerator Test Facility: www-atf.kek.jp/atf/
- [3] B. I. Grishanov et al., ATF2 proposal, vol. 1, KEK-2005-2, 2005.
- [4] FONT: www-pnp.physics.ox.ac.uk/~font/
- [5] R. J. Apsimon et al., PRST-AB, vol. 18, p. 032803, 2015.
- [6] N. Blaskovic Kraljevic, DPhil thesis, Oxford University, 2015.